

# SISTEMA DE FIXAÇÃO TUBULAR

## Tubular Fixation System

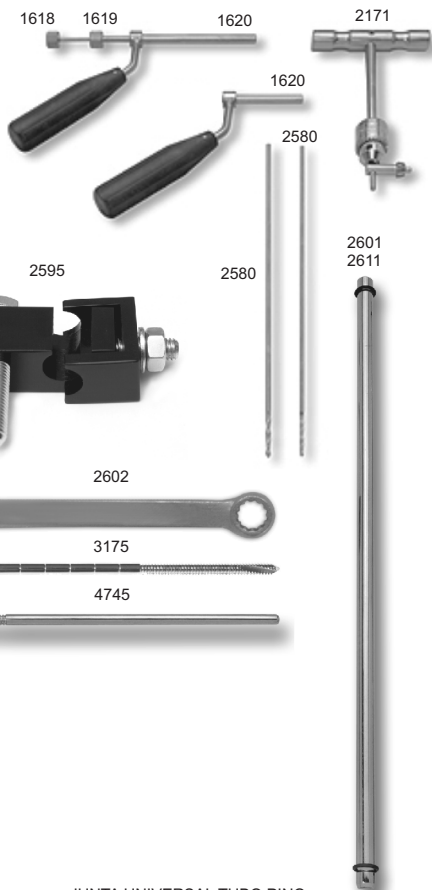

1618	PERFURADOR PUNÇÃO GRANDE <i>Large Punch</i>
1619	GUIA DE BROCA GRANDE <i>Large Drill guide</i>
1620/01	GUIA PROTETOR PEQUENO <i>Small Protection Guide</i>
1620/02	GUIA PROTETOR GRANDE <i>Large Protector Guide</i>
2580/03	BROCA Ø 2,5X250 mm <i>Drill</i>
2580/04	BROCA Ø 3,2X250 mm <i>Drill</i>



### TUBO AÇO INOX Ø 10 mm

*Stainless Steel Tube*

REF.	COMPR. Length
2601/01	100
/02	200
/03	250
/04	300
/05	400



### TUBO AÇO INOX Ø 11 mm

*Stainless Steel Tube*

REF.	COMPR. Length
2611/01	100
/02	200
/03	250
/04	300
/05	400

Inox  
Stainless Steel  
ISO 5832-1  
ASTM F.139

2171	CHAVE "T" <i>"T" Wrench</i>
2595/01	CONECTOR PARA ALONGADOR DO TUBO Ø 10 mm <i>Connector For Tube Extender</i>
2595/02	CONECTOR PARA ALONGADOR DO TUBO Ø 11 mm <i>Connector For Tube Extender</i>
2602	CHAVE COMBINADA 10 X 10 mm <i>Combined Wrench</i>
3175/03	PINO DE SCHANZ Ø 5 x 150mm <i>Schanz Pin</i>
4745/01	PINO DE SCHANZ Ø 4,8 mm x 160 mm <i>Schanz Pin</i>
4745/02	PINO DE SCHANZ Ø 4,8 mm x 200 mm <i>Schanz Pin</i>

### JUNTA UNIVERSAL TUBO PINO

*Tube Pin Universal Joint*

REF.	Ø
2599/01	10mm
/02	11mm

### JUNTA UNIVERSAL TUBO TUBO

*Tube Tube Universal Joint*

REF.	Ø
2600/01	10mm
/02	11mm

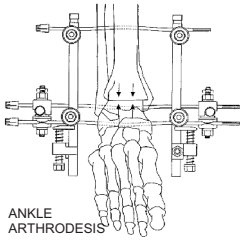

**ANKLE ARTHRODESIS**

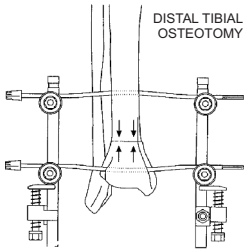

**DISTAL TIBIAL OSTEOTOMY**

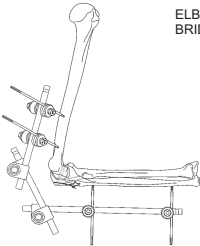

**ELBOW BRIDGE**

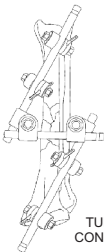

**TIBIA TUBE TO TUBE CONSTRUCTION**

**KNEE ARTHRODESIS**

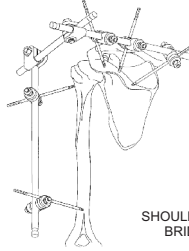

**SHOULDER BRIDGE**

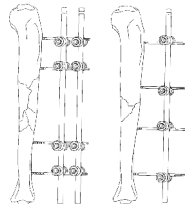

**TIBIA DOUBLE-TUBE CONSTRUCTION**

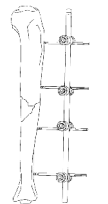

**TIBIA SINGLE-TUBE CONSTRUCTION**

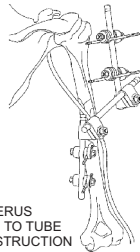

**HUMERUS TUBE TO TUBE CONSTRUCTION**

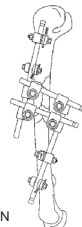

**FEMUR TUBE TO TUBE CONSTRUCTION**

**PROXIMAL TIBIAL OSTEOTOMY**

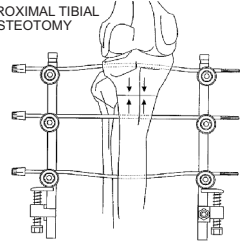

**ANKLE BRIDGE**

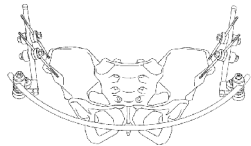
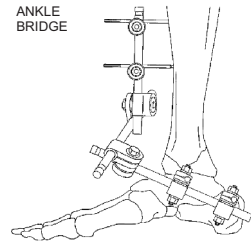

**PELVIS OPEN BOOK INJURY. FRAME WITH CURVED, CARBON FIBRE ROD.**

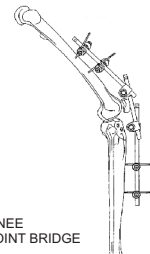

**KNEE JOINT BRIDGE**